

VHF FM TRANSCEIVER

DJ-193

UHF FM TRANSCEIVER

DJ-493

Instruction Manual

Thank you for buying this ALINCO transceiver.
This instruction manual contains important safety and operating instructions. Please read it carefully before using the transceiver.

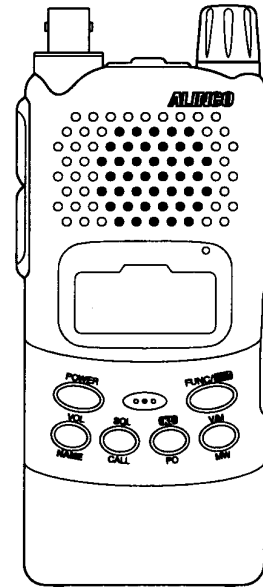

ALINCO, INC.

Head office: "TWIN 21" MID Tower Building 25F
1-61, 2-Chome, Shiromi, Chuo-ku, Osaka 540-8580, Japan
Phone: 06-6946-8150 Fax: 06-6946-8175
E-mail: export@alinco.co.jp

U.S.A.: 438 Amapola Avenue, Unit 130, Torrance, CA 90501-6201, U.S.A.
Phone: 310-618-8616 Fax: 310-618-8758
<http://www.alinco.com/>

Germany: Eschborner Landstrasse 55, 60489 Frankfurt am Main, Germany
Phone: 069-786018 Fax: 069-789-60766
<http://www.alinco.de/>

NOTICE

This equipment has been tested and found to comply with the limits for a Class B digital device, pursuant to part 15 of the FCC Rules. These limits are designed to provide reasonable protection against harmful interference in a residential installation. This equipment generates, uses, and can radiate radio frequency energy and, if not installed and used in accordance with the instruction manual, may cause harmful interference to radio communications. However, there is no guarantee that interference will not occur in a particular installation. If this equipment does cause harmful interference to radio or television reception, which can be determined by turning the equipment off and on, the user is encouraged to try to correct the interference by one or more of the following measures:

- *Reorient or relocate the receiving antenna.*
- *Increase the separation between the equipment and receiver.*
- *Connect the equipment into an outlet on a circuit different from that to which the receiver is connected.*
- *Consult the dealer or an experienced radio/TV technician for help.*



Tested to Comply
With FCC Standards
FOR HOME OR OFFICE USE

Information in this document are subject to change without notice or obligation. All brand names and trademarks are the property of their respective owners. Alinco cannot be liable for pictorial or typographical inaccuracies. Some parts, options and/or accessories are unavailable in certain areas. Changes or modifications not expressly approved by the party responsible for compliance could void the user's authority to operate the equipment.

Copyright © 1998 All rights reserved. No part of this document may be reproduced, copied, translated or transcribed in any form or by any means without the prior written permission of Alinco, Inc., Osaka, Japan. English Edition Printed in Japan.

2

PRECAUTIONS

CAUTION



Do not open the transceiver case or touch non-user-serviceable components



Do not expose the product to direct sunlight or heat sources. Also, avoid using the product in an extremely dusty or humid environment.



Do not place anything, which might spill on top of or over the product.



Do not yank the power cord from its outlets. Also, do not rewire the power cord with other extension cords. Such handling may damage or short circuit the cord.



Use a 13.8 V DC regulated power supply to operate this product. The transceiver must be grounded.



Beware of moisture condensation.

Moisture in the air will condense on the product when you move it from a cold place to a warm place. Condensation will cause the unit to malfunction. If condensation forms on the unit, wipe or let dry.



For good ventilation, allow about 10 cm between the rear of the product and the wall.



If the product causes harmful interference to VCR or TV reception, move the product away from the appliance.



If the product ever emits smoke or strange smells, immediately turn it off and unplug the power cord. Then, contact your authorized dealer.

BEFORE OPERATING THE TRANSCEIVER

■ Attention

- Do not remove the case or touch the interior components. Tampering can cause equipment trouble.
 - Do not use or keep the transceiver where it is exposed to direct sunlight, dusty places, or near sources of heat.
 - Keep the transceiver away from TVs, tuners or other equipment when it interferes with reception.
 - Securely connect the antenna which has been included with the transceiver.
 - For external power, Alinco recommends using the EDC-36 cigarette lighter cable with filter.
 - When transmitting for a long time at high power, the transceiver can overheat.
 - Turn the power off immediately if the transceiver emits smoke or strange odors.
- Ensure the transceiver is safe, then bring it to the nearest Alinco service center.

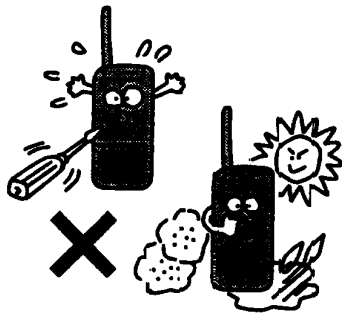

■ Points to Note Before Transmitting

Many wireless stations use frequencies adjacent to the ham bands for business purposes. Be mindful when transmitting near them.
Even when amateur stations obey radio laws, unexpected jamming can occur.
Pay sufficient attention during mobile operation.

⚠ CAUTION

Depending on laws in different region, it may be forbidden to use the transceiver in the following place :

- Aboard aircraft
- In airports
- In ports
- Within or near the operating area of business wireless stations or their relay stations.

Before use in any or the above places, obtain any necessary permission from the proper authorities and be mindful of local laws that govern amateur radio operation.

■ Points to Note for Using an External Power Supply

- Use a 7.0V-16.0V DC power supply as an external power supply.
- When connecting the power supply to the transceiver, use an optional DC cable for base station (EDC-37). Connect the cable to the DC jack on the side of the transceiver.
- When the power is supplied from a cigarette socket of a car, use the cigarette lighter cable (EDC-43) or the cigarette lighter cable with filter (EDC-36). Use the cigarette lighter cable with filter (EDC-36) during mobil operation to prevent noise.
- Turn the power off when connecting or disconnecting the DC cable.

6

1 FEATURES

This transceiver has the following main features.

- 39 CTCSS tone squelch functions.
- 104 DCS digital code squelch functions.
- TOT function can be set to Duty Cycle most accommodating to the user's requirements.
- Naming Memory Channels function
- Tone Burst function (1750, 2100, 1000, 1450Hz)
- Cable Cloning function
- Theft Alarm function
- Mosquito Repel sound function
- Equipped with a high performance antenna.

1.1 Accessories

- Ni-Cd battery pack EBP-48N(9.6V 700mAh)
 - EDC-93(120V AC)Wall charger(T version)**
 - EDC-94(230V AC)Wall charger(E version)**
 - Flexible rubber duckie antenna
 - Belt clip
 - Hand strap
 - Instruction Manual
 - Warranty**
- ** Accessories may differ depending on the version you bought.

1

2

2 ACCESSORIES

2.1 Connecting the Accessories

● Connecting and Disconnecting the Antenna

• Attaching the Antenna

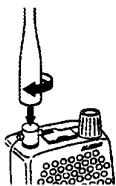

1. Hold the antenna by its base.
2. Align the grooves at the base of the antenna with the protrusions on the antenna connector.
3. Slide the antenna down and turn it clockwise until it stops.
4. confirm that the antenna is securely connected.

• Detaching the Antenna

Turn the antenna counter-clockwise to disconnect the antenna.

● Attaching the Hand Strap



Attach the hand strap as shown in the illustration on the left.

7

● **Attaching and Detaching the Belt Clip**

• **Attaching the Belt Clip**
Attach the belt clip to the back of the transceiver until it clicks.

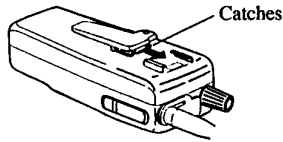

• **Detaching the Belt Clip**
Push up the catches of the belt clip, and pull it.

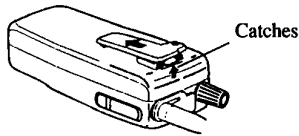

● **Attaching and Detaching the Ni-Cd Battery Pack**

• **Attaching the Ni-Cd Battery Pack**
Align with the grooves on the transceiver, and slide in the direction of the arrow until it clicks.

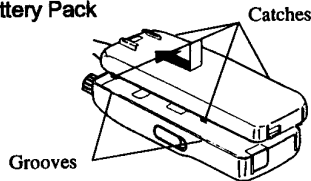

• **Detaching the Ni-Cd battery pack**
Push up the catches, and pull the battery pack or free of the transceiver.

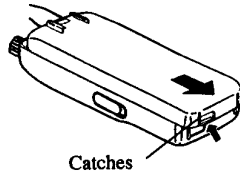

● **Prevent Short Circuiting the Ni-Cd Battery Pack**

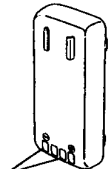

Be extra cautious when carrying the Ni-Cd battery pack; short circuiting will produce surge current possibly resulting in fire.

Terminals

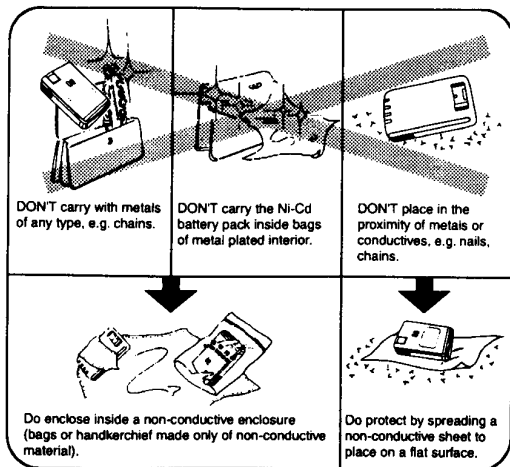

⚠ **CAUTION**

- Keep the battery pack inside the included pouch when carrying.

⚠ **CAUTION**

- The battery pack is not charged when shipped. It must be charged before use.
- It takes 12 hours maximum to fully charge the battery pack with the EDC-93/94.
- Charging should be conducted in a temperature range or 0°C to 40°C. (32°F-104°F)
- Do not modify, dismantle, incinerate or immerse the battery pack in the water as this can be dangerous.
- Never short-circuit the battery pack terminals, as this can cause damage to the equipment or lead to heating of the battery which may cause burns
- Unnecessary prolonged charging (overcharging) can deteriorate battery performance.
- The battery pack should be stored in a dry place where temperature is from -20°C to +45°C. (-4°F-+113°F) Temperatures outside this range can cause the battery liquid to leak. Exposure to prolonged high humidity can cause corrosion of metal components.
- Normally, the battery pack can be charged up to 500 times. However, the battery pack can be considered dead if the period of use drops off markedly despite the pack being charged for the aforementioned charging time. When this happens, a new pack should be used.
- The battery is recyclable. At the end of its useful life, under various national and local laws, it may be illegal to dispose of this battery improperly. Check with your local solid waste officials for details on recycling options or proper disposal in your area.
- When this battery is mounted on the Transceiver, it can be charged by connecting 13.8V DC-IN.

● **Wall Charger (EDC-93(120V), EDC-94(230V))**

• Recharging with the EDC-93(120V), EDC-94(230V)

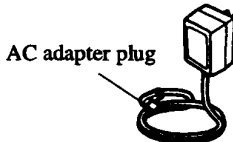

1. Mount the Ni-Cd battery pack on the transceiver.
2. Connect AC adapter plug to the external power supply jack on the transceiver.
3. Connect to the AC outlet.

⚠ **CAUTION**

- Turn the transceiver power off before recharging the battery pack.
- Disconnect the EDC-93/94 from the outlet while not using it.
- Never charge battery packs of other manufacturers with this charger.
- The required recharging time depends on the condition and model of battery pack. Refer to the instruction manual or the battery pack.
- Never short-circuit the recharging terminals of this recharger with metal objects, etc. The charger can be damaged.
- The EDC-93/94 does not work when the voltage from the wan outlet is extremely low.
- The EDC-93/94 can not be used as the external DC cable.

● **Ni-Cd Battery Charge Indicator**

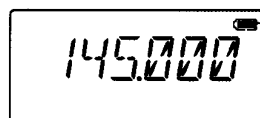

Charge indicator
Display Battery charge
 Enough battery charge remaining.
 Battery charge is low. Recharge.

- The battery charge indicator display can vary substantially depending on the ambient temperature and the frequency of use.
- It is still possible to perform LOW output transmission and reception for a period, even when the indicator suggests that recharging is required.

3 NAMES AND OPERATION OF PARTS

3.1 Names and Operation of Parts

● Top and Front

3

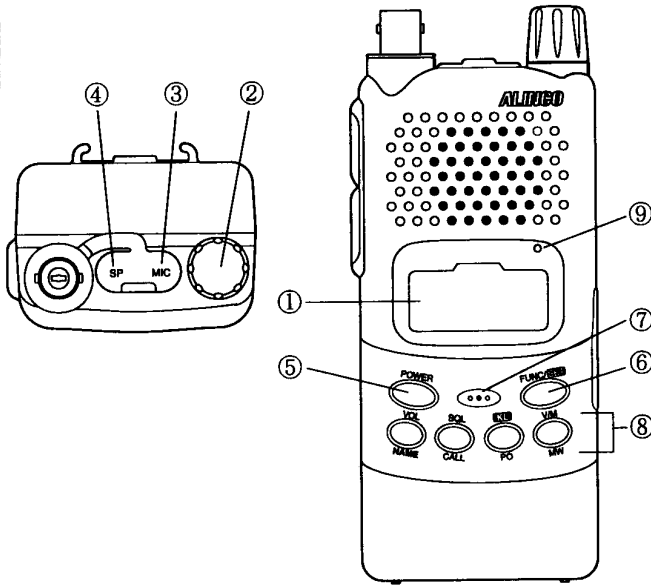

①	Display(LCD)	Refer to "About the display" in this manual.
②	Dial	Rotate the dial to select the transmission / reception frequency, memory channel, offset frequency, tone frequency, DCS code, SET mode settings, and the characters for memory name input. Rotating the dial while pressing the FUNC key increases or decreases the frequency in steps of 1MHz.
③	Microphone jack	For connection of an external microphone (2k Ω) with φ 2.5 stereo plug.
④	Speaker jack	For connection of an external speaker (8 Ω) with φ 3.5 mono plug.
⑤	POWER key	Press the POWER key down for approximately 1 sec. to toggle the transceiver on and off.
⑥	FUNC key	The FUNC key is used in combination with the other keys to access the various functions of the transceiver. To enter SET mode to and modify the settings, press the FUNC key continuously for about two seconds.
⑦	Microphone	Speak into the microphone from a distance of about 5cm (2").
⑧	Keypad	Keypad. (→ page 12)
⑨	TX / RX lamp	Lights green when the squelch is unmuted. Lights red during transmission.

10

● Side

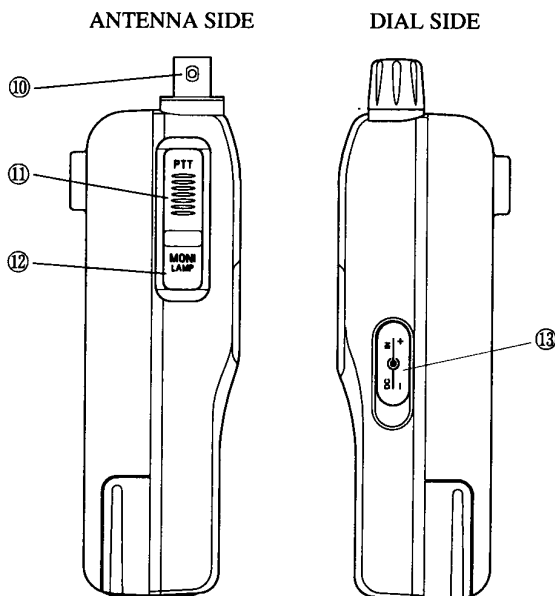

⑩	BNC Antenna Connector	For connection of the accessory helical antenna (plug it in securely). If you plan to use another antenna, select one that has a low SWR (Standing Wave Ratio).
⑪	PTT key	Press the PTT key to transmit. When you release the PTT key, the transceiver reverts to receiving.
⑫	MONI key	When the MONI key is pressed, the squelch unmutes, and the received signal is audible. The squelch is unmuted regardless of the TSQ/DCS setting. Pressing the MONI key when FUNC is displayed causes the illumination lamp to go on for about five seconds. Pressing the MONI key while pressing the PTT key transmits a tone burst signal.
⑬	DC-IN jack	Plug for connection of an external power supply. This can be used to power the transceiver from an automobile cigarette lighter using the optional Alinco EDC-36 cable (with filter). The jack polarity is + in the center and - on the outside. When using an external power supply, it should have a voltage output in the range DC7.0V to DC16.0V, 2A (min.), and be regulated.

3

3.2 Keypad

3

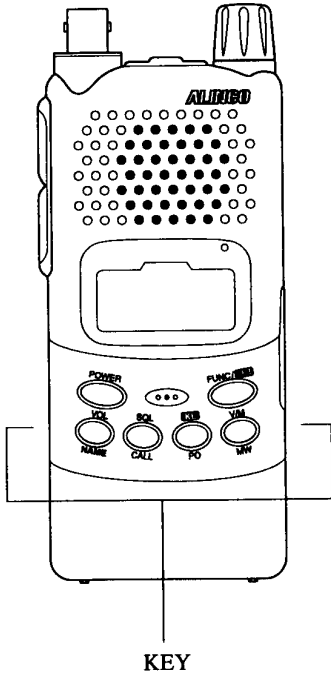

KEY		While F appear after the key is pressed.
	Enters volume adjustment mode. (page 15)	Channel name settings (page 20)
	Enters squelch adjustment mode. (page 14)	Accesses call channel. (page 17)
	Key lock settings (page 19)	Switches transmission output between high and low. (page 18)
	Switches between VFO mode and memory mode. (page 15)	Writes to memory. (page 16)

12

3.3 Display (LCD)

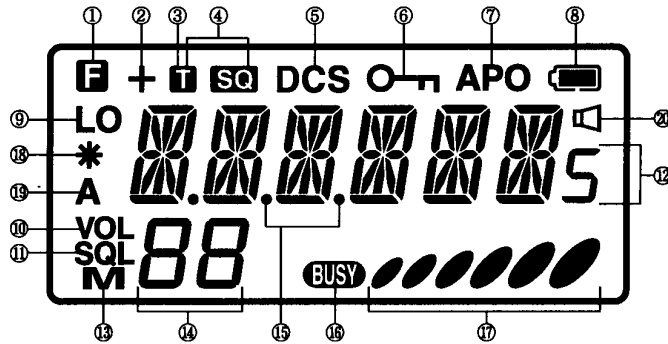

3

①	F	Appears when key is pressed.	⑪	SQL	Displayed when the squelch is being adjusted.
②	+	Indicates the shift (+/-) direction.	⑫		Displays the transmission/reception frequencies, and the content of the various settings.
③	T	Appears when setting the tone encoder.	⑬	M	Displayed when in Memory mode.
④	T SQ	Appears when setting the tone squelch.	⑭	88	Displays the memory channel No. and the various setting levels.
⑤	DCS	Appears when setting the DCS.	⑮	.	Displays the frequency and scan operation.
⑥		Displayed when the frequency or the keypad is locked.	⑯	BUSY	Appears when the squelch is unmuted.
⑦	APO	Appears when Auto Power Off function is activated.	⑰		Indicates the receiving level and transmission output level.
⑧		Battery charge indicator.	⑱	*	Displayed when the Theft Alarm function is on.
⑨	LO	Displayed when the transmission output is LOW.	⑲	A	Displayed when the External Control function is on.
⑩	VOL	Display when the volume is being adjusted.	⑳		Displayed when the MRS function is on.

4 BASIC OPERATION

4.1 Turning the Power On

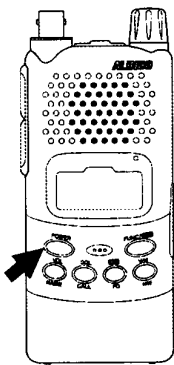

Hold the  key down for a second.

To turn the power off, hold the  key down until the indication disappears.

4

One of the default frequencies should appear on the display.

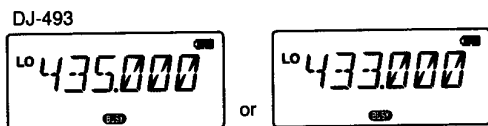
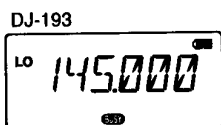

4.2 Adjusting the Squelch

The squelch silences the transceiver except for signals above a certain level. Squelch eliminates the noise when the transceiver receives less than a certain level. "To unmute the squelch" means that the transceiver receives the signal and reproduces the sound.

- There are 21 squelch levels (00–21).
- The default setting is Level 00.

1. Press the  key. "SQL" and the squelch level are displayed on the LCD.

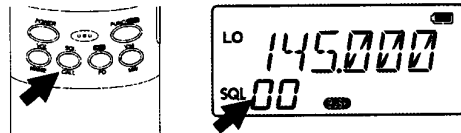

2. Rotate the dial to increase or decrease the squelch level. At large setting values, the squelch unmutes at strong signal levels.
3. Press any key except for the MONI key to complete setting. If the dial is not operated for a period of about five seconds, the setting is completed automatically, and the transceiver returns to the normal display.

14

4.3 Adjusting the Volume

- There are 21 volume levels (00–21).
- The default setting is Level 00. There is no audio when the setting is 00.

1. Press the  key. "VOL" and the volume level are displayed on the LCD.

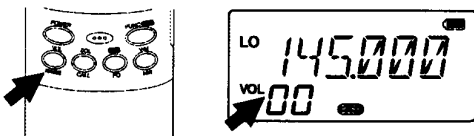



2. Rotate the dial to increase or decrease the volume level. As the setting values increases, the volume becomes louder.
3. Press any key except for the MONI key to complete setting. If the dial is not operated for a period of about five seconds, the setting is completed automatically, and the transceiver returns to the normal display.

4.4 Setting the Frequency in the VFO Mode

The factory setting for the transceiver is the VFO mode. The VFO mode allows you to change the frequency and other settings.

● Setting the Frequency

Press the  key to enter VFO mode. The transceiver toggles between VFO mode and Memory mode each time the  key is pressed.

"M" is displayed on the LCD when the transceiver is in Memory mode, and nothing is displayed when the transceiver is in VFO mode.

Adjusting the frequency in tuning steps

Rotate the Dial clockwise one click to increase the frequency by one tuning step.

Rotate the Dial counter-clockwise one click to decrease it by one tuning step.

Adjusting in 1MHz steps



Press the  key, and while **F** is displayed on the LCD, rotate the dial to increase or decrease (depending on the direction of rotation) the frequency in steps of 1MHz.

4

4.5 Memory Mode

This mode allows you to call up previously stored frequencies. The transceiver has 40 memory channels (0CH to 39CH). It is not possible to increase the amount of memory.

● Calling Up a Memory Channel

1. Press the  key to enter Memory mode. The transceiver toggles between VFO mode and Memory mode each time the  key is pressed.

"M" is displayed on the LCD when the transceiver is in Memory mode, and nothing is displayed when the transceiver is in VFO mode.

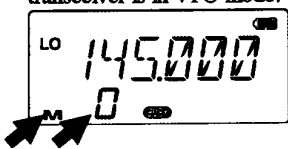



"M" flashes for memory channels that are not being used, and the VFO frequency is displayed.



2. Rotate the dial to display the memory channel No. that you want.

Clockwise rotation : each click increases the memory channel No. by one.

Counter-clockwise rotation : each click decreases the memory channel No. by one.

3. Press the  key, and while  is displayed on the LCD, press the  key. A beep sounds, the frequency stored in the selected memory channel No. is deleted, and "M" flashes on the display.

NOTE





- When "M" is flashing in setup 3 (when the memory contents are displayed as is on the display), it is possible to retrieve the deleted memory contents by press the  key, and while  is displayed on the LCD, press the  key. After changing memory channels or modes, this is no longer possible.

● Items that can be Stored in Memory

The following items can be stored in each of the memory channels (CH0 to CH39).

- Frequency
- Offset frequency
- Shift direction (+/-)
- Tone encoder frequency
- Tone decoder frequency
- Tone encoder/decoder setting
- DCS code
- DCS setting
- Skip channel setting
- Busy channel lockout (BCLO)
- Transmission power (H/L)
- Battery save setting
- Clock shift setting
- Alphanumeric channel tag

● Writing to a Memory Channel

1. Press the  key to enter Memory mode.
2. Rotate the dial to select the memory channel No. that you want. "M" flashes for memory channels that are not being used.
3. Press the  key again to enter VFO mode.
4. Select the frequency that you want to write to, and set the shift and tone functions as required.
5. Press the  key, and while  is displayed on the LCD, press the  key. The VFO frequency is written to memory channel and the completion beep sounds.

NOTE

- If at step 2, you select the memory channel that is already being used, step 4 clears the memory and "M" flashes on the display.
- If  is selected for the memory channel, the call channel is also written to.



● Deleting a Memory Channel

1. Press the  key to enter Memory mode.
2. Rotate the dial to select the memory channel No. that you want to delete. "M" is displayed for memory channels that are being used.

4.6 Call Mode

This mode is used to standby on a call channel, or to call up a call channel.

The transceiver has one call channel. The initial frequency setting. ( 10.2 Resetting CALL Frequency)

1. Press  key and then press  key while  is displayed. The transceiver will enter call mode and "C" will appear in the display.

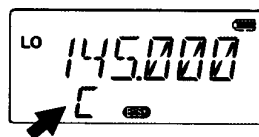

2. Repeating the procedure in step 1 will return the transceiver to VFO mode or memory mode.

Pressing the  key will also return the transceiver to VFO mode or memory mode.

IMPORTANT

- It is not possible to use the dial to change the Call mode frequency or memory channel No.
- It is possible to temporarily change the offset and CTCSS/DCS settings and operate the unit.
- The Scan function cannot be used when in Call mode.

● Changing the Call Channel Frequency

The call channel is allocated as one memory channel. Therefore,



to change the call frequency or other settings, call up the memory channel from VFO mode or Memory mode (4.5 Memory mode, page 16).

IMPORTANT

- The call channel frequency can be modified but not deleted.

4.7 Receiving

4

1. Switch the transceiver power on.
2. Press the  key and rotate the dial to increase the volume level as necessary.
3. Press the  key and rotate the dial to the setting at which the noise disappears.
4. Select the frequency that you want. When a signal is received on the frequency that you selected, **BUSY** is displayed on the LCD, and the received signal can be heard. The green RX indicator also lights at this time.

● Monitor function

This function can be used to temporarily switch off the squelch when the received signal is weak or breaking up and is difficult to copy.

- The squelch is unmuted while the MONI key is pressed, regardless of the squelch level setting.
- This function unmutes the squelch even if the DCS and Tone Squelch functions are set.

4.8 Transmitting



1. Select the frequency that you want.
2. Press the PTT key.
The red TX indicator will light.
3. While holding down the PTT key, speak into the microphone on the transceiver at normal speaking volume.
4. When you have finished speaking, release the PTT key.

IMPORTANT

- To transmit a tone burst signal, press the MONI key while holding down the PTT key.
- Pressing the PTT key outside the transmission frequency range causes "OFF" to be displayed on the LCD. Transmission is not possible in this state.



● Switching Transmission Output Level

It is possible to change the transmission output level.

Press the  key, and while  is displayed on the LCD, press the  key to toggle between high and low transmission power output.

When low transmission power output is selected, "LO" is displayed on the LCD. Nothing is displayed when high power is selected.

The initial setting is low power.

The RF meter display is  when transmitting at low power, and  when transmitting at high power.

IMPORTANT

- It is not possible to switch the power setting during transmission.

5 USEFUL FUNCTIONS

5.1 Scan Modes



This function automatically changes the transceiver frequency to help you locate the signal that you want to receive.

- **Busy scan**
After scanning stops, if no signal is present, the transceiver switches to the next channel.
- **Timer scan**
After scanning stops, even if a signal is present, the transceiver switches to the next channel after five seconds.
- During scanning, the 1MHz decimal point (.) on the frequency display flashes. The Monitor function operates.
- Press any key other than the MONI key to stop scanning.
- Scanning is started in the direction of the last dial operation (up or down).

NOTE



- Use Set mode to switch the setting between Timer scan and Busy scan.

● VFO Scan

1. Press the  key again to enter VFO mode.
2. Press the  key for at least two seconds to start scanning.
Scanning is performed in the tuning step units in the direction of the last operation.
3. Rotating the dial in the clockwise direction makes the scanning take place in the up direction, and rotating it in the counter-clockwise direction makes the scanning take place in the down direction.
VFO SCAN scans the entire frequency range.

4. Press any key other than the MONI key to stop scanning.

● Memory Scan

1. Press the  key again to enter Memory mode.
2. Press the  key for at least two seconds to start memory scanning.
3. Rotating the dial in the clockwise direction makes the scanning take place in the up direction, and rotating it in the counter-clockwise direction makes the scanning take place in the down direction.
Memory Scan scans the frequencies stored in memory.
4. Press any key other than the MONI key to stop scanning.

● Setting Skip Channels

Memory channels that are set as skip channels are skipped during a memory scan.

NOTE

- Skip channel is set in setting mode (4.29 page 29).

5.2 Keylock

Press the  key for at least two seconds to set the Keylock function on.

- When the Keylock function is on, the  mark is displayed on the LCD.
- When the Keylock function is on, the PTT, LAMP, and MONI keys can be operated, and the VOL and SQL levels, and tone burst transmission output can be changed.

5

- To switch off the Keylock function, press the  key for at least two seconds again.

5.3 Tone Burst



- This function is needed to access European repeaters.
- To output the tone burst signal, press the MONI key while holding down the PTT key (the tone burst is output for the duration that the keys are pressed).
The initial setting for the tone burst signal frequency is 1750Hz, but this can be changed using Set mode (Chapter 8 Set Mode ((page 26))).
 - When Tone and DCS are set, the tone frequency and DCS code are appended to the transmission.

5





5.4 Naming Memory Channels

In Memory mode, it is possible to display a string of alphanumeric characters (channel name) in place of the frequency setting.

● Setting Method

- In Memory mode, select the channel that you want to set a channel name for.
- Press the  key, and while **F** is displayed press the  key.
- [A] flashes on the display.
- Rotate the dial to select a character for input.
- Press the  key to input the character. The character will stop flashing.
- The same character as the one just input is displayed flashing at the position on the right of the last input character.

20

- Press the  key to confirm (sequential input).
- Press the  key during input to delete all input characters.
- Press any key (except MONI, , or ) to complete input and return to the channel name display.

● Using the Channel Name function

- In memory mode, the alphanumeric names set for the channels are displayed in the frequency display area (the channel number is displayed as it normally is).
- Press the  key to switch from the channel name display to the frequency display for five seconds (pressing any other key during this time reverts to the channel name display). However, if a function is allocated to the key that is pressed, the transceiver enters the SET mode for that key.

5.5 Lamp

Press the  key, and while **F** is displayed on the LCD, press the MONI key to light the display backlight.

- The backlight automatically switches off if there is no operation for five seconds.
- Pressing any key other than the LAMP key when the backlight is on extends the on period for another five seconds.
- Switching the power on while pressing the MONI key switches the lamp on permanently.
- When the lamp has been switched on permanently, pressing the  key and then the MONI key switches the lamp on and off.

6 COMMUNICATING

■ Selection Calling Method

- To communicate with a particular station, use either the Tone Squelch function or the DCS function.
The Tone Squelch function unmutes the squelch when one of the 39 tone frequencies set for the transceiver matches the tone frequency of another station.
- The DCS function unmutes the squelch when one of the 104 digital codes set for the transceiver matches the digital code of another station.
- It is not possible to use the Tone Squelch and DCS functions at the same time.

6.1 Tone Squelch

● Setting the Tone Squelch

- In setting mode, turn the dial to set .

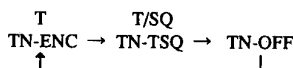

- Pressing any key other than the MONI key or  key will complete the setting and return the transceiver to normal status.

- When only **T** is displayed, only the Encoder function can be set.
- When **T SQ** is displayed, the Encoder and Decoder (tone squelch) functions can be set.
- The Monitor function also works while the tone frequency is displayed.

● Setting the Tone Frequency.

Turn the dial to select set mode **885**.

- While the tone frequency is displayed, turn the dial to select the tone frequency to use from among the standard tones listed below.

										(Hz)
67.0	69.3	71.9	74.4	77.0	79.7	82.5	85.4			
88.5	91.5	94.8	97.4	100.0	103.5	107.2	110.9			
114.8	118.8	123.0	127.3	131.8	136.5	141.3	146.2			
151.4	156.7	162.2	167.9	173.8	179.9	186.2	192.8			
203.5	210.7	218.1	225.7	233.6	241.8	250.3				

● Changing the Tone Frequency Setting

It is possible to set the tone encoder and tone decoder frequencies independently.

- If you change the encoder frequency when **T** is displayed, the decoder frequency is automatically changed to the same frequency.
- If you change the frequency when **T SQ** is displayed, only the decoder frequency is changed (it is possible to set different frequencies for ENC/DEC).

6

●Tone Squelch Operation

1. The squelch is unmuted when the received frequency matches the setting frequency.

6.2 DCS

●Setting the DCS

1. In setting mode, turn the dial to set.

DCS
DCS-OF → 023 ... 754
↑

- The monitor function also works while the code is displayed.
2. Pressing any key other than the MONI key or  key will complete the setting and return the transceiver to DCS display and normal display.

●Changing the DCS Code

The DCS code can be set in DCS code setting mode (while DCS is displayed).

- The same DCS code is set for ENC/DEC.

One of the following 104 DCS codes can be selected.

023	025	026	031	032	036	043	047	051	053
054	065	071	072	073	074	114	115	116	122
125	131	132	134	143	145	152	155	156	162
165	172	174	205	212	223	225	226	243	244
245	246	251	252	255	261	263	265	266	271
274	306	311	315	325	331	332	343	346	351
356	364	365	371	411	412	413	423	431	432
445	446	452	454	455	462	464	465	466	503
506	516	523	526	532	546	565	606	612	624
627	631	632	654	662	664	703	712	723	731
732	734	743	754						

●DCS Operation

The squelch unmute when the received code matches the set code.

6

22

7 SPECIAL FUNCTIONS

7.1 Theft Alarm Function

This function outputs an alarm signal from the speaker if the transceiver is stolen.

●Setting

Be certain to install the battery pack.

1. Plug in the external DC power supply cord (connect the cord to a automobile power supply etc.).
2. Set SCR-ON in Set mode ( Chapter 8 Set Mode (page 27)).

“*” is displayed on the LCD.

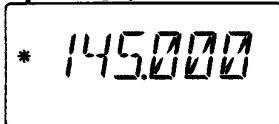

3. Switch off the power supply to the transceiver.
 - To switch the setting off, set SCR-OF in Set mode.

●Operation

- When the power cord is unplugged to take away the transceiver, the theft alarm sounds.
- Once it starts, the alarm output can only be stopped by removing the battery pack. Install the battery pack, switch the power on, and use Set mode to switch off the alarm.
- During normal operation, be certain to set SCR-OF.

IMPORTANT

- Never fail to push and hold Power key for more than 1sec. To turn the radio on, when the Theft Alarm function is set.

7.2 External Control Function

This function outputs 5V from the MIC jack when the speaker output is on.

- Set EXP-ON in Set mode ( Chapter 8 Set Mode (page 27)).

“A” is displayed on the LCD.

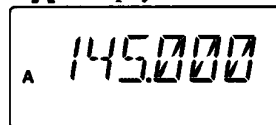

- When a signal is received (when the tone matches in the case that TSQ/DCS is set), DC5V (5mA max.) is output from the center terminal of the MIC stereo jack.
- To switch this function off, set EXP-OF in Set mode. When the External Control function is on (EXP-ON), it is not possible to use the optional VOX MIC (EME-12, EME-13 and EME-15) etc.

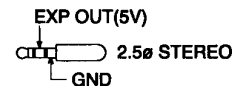

7

23

7.3 Mosquito Repel Sound (MRS)

This function outputs a high-frequency mosquito-repelling signal from the speaker.

- Use Set mode to set MRS-ON (Chapter 8 Set Mode (page 27)).

 is displayed on the LCD.

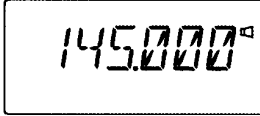

- Normal operation is possible when MRS is set.
- The MRS function generates a high-frequency signal, so battery life becomes somewhat shorter.
- To switch the MRS function, set MRS-OF in Set mode.

IMPORTANT

- There are many thousand of mosquito varieties, and some may not be repelled by the MRS frequency.

7

8 SET MODE

The set mode is used to set the various operation functions.



8.1 Set Mode Operation

Default	Function
1. BS-ON	Battery Save ON/OFF
2. TIMER	Timer/Busy scan switching
3. BEP-ON	Beep sound ON/OFF
4. 1750	Tone Burst Frequency switching
5. SFT-OF	CPU Clock Frequency shift ON/OFF
6. BCL-OF	Busy Channel Lock Out ON/OFF
7. T-OFF	Timeout timer time ON/OFF
8. TP-OFF	TOT Penalty ON/OFF
9. SCR-OF	Theft Alarm ON/OFF
10. EXP-OF	External Terminal Control ON/OFF
11. MRS-OF	Mosquito Repel Sound ON/OFF
12. STP-5	Channel step setting Note: Not shown in memory mode.
13. SFD-OF	Shift direction ON/OFF
14. 0.600	Shift frequency setting
15. TN-OFF	Tone squelch switching/cancel
16. 88.5	Tone frequency setting
17. DCS-OF	DCS ON/OFF
18. APO-OF	Auto power off ON/OFF
19. SKP-OF	Skip channel ON/OFF Shown only in memory mode.



- Cut out the Set Mode Function List right side for use as a reference.

8.2 Set Mode Setting Method

1. Press the  key for at least two seconds.
The transceiver will enter Set mode.
"BS-ON" is displayed in the initial menu.
 2. Press the MONI key or  key to select a menu.
The Monitor function cannot be used in this state.
 3. Rotate the dial to change the setting contents.
 4. Press any key other than the MONI key or  key will complete the setting and return the transceiver to normal display.
- The next time that you enter Set mode, the most recently used setting menu is displayed.

REFERENCE(SET MODE)

Default	Function
1. BS-ON	Battery Save ON/OFF
2. TIMER	Timer/Busy scan switching
3. BEP-ON	Beep sound ON/OFF
4. 1750	Tone Burst Frequency switching
5. SFT-OF	CPU Clock Frequency shift ON/OFF
6. BCL-OF	Busy Channel Lock Out ON/OFF
7. T-OFF	Timeout timer time ON/OFF
8. TP-OFF	TOT Penalty ON/OFF
9. SCR-OF	Theft Alarm ON/OFF
10. EXP-OF	External Terminal Control ON/OFF
11. MRS-OF	Mosquito Repel Sound ON/OFF
12. STP-5	Channel step setting Note: Not shown in memory mode.
13. SFD-OF	Shift direction ON/OFF
14. 0.600	Shift frequency setting
15. TN-OFF	Tone squelch switching/cancel
16. 88.5	Tone frequency setting
17. DCS-OF	DCS ON/OFF
18. APO-OF	Auto power off ON/OFF
19. SKP-OF	Skip channel ON/OFF Shown only in memory mode.

8

8.3 Functions Set in Set Mode

The following function can be set using the Set mode.

●1. Battery Save (BS) Function

This function prevents battery charge wastage by switching the reception circuit power supply on/off using a fixed ratio if there is no key operation or received signal for a continuous period of five seconds or more.

1. BS-ON is displayed on the LCD.
2. Rotate the dial to change the battery save setting (on or off).

BS-ON → BS-OFF
↑

- The factory setting is BS-ON.
- The Battery Save function is temporarily switched off if a key is operated or if a signal is received.

●2. Switching the Scanning Type Function

Switches between Timer scan and Busy scan.

1. TIMER is displayed on the LCD.
2. Rotate the dial to switch the scanning type setting between TIMER and BUSY.

TIMER → BUSY
↑

●3. Beep Function

This function causes a beep to sound when a key is operated.

1. BEP-ON is displayed on the LCD.
2. Rotate the dial to toggle the beep setting on and off.

BEP-ON → BEP-OFF
↑

- ③When the codes match and the squelch is unmuted based on the DCS setting conditions.

●7. Time Out Timer (TOT)

This function stops the transmission automatically when the continuous transmission time exceeds the set time.

1. T-OFF is displayed on the LCD.
2. Rotate the dial to change the TOT time.
TOT time can be set to a maximum of 450 sec.

OFF → 30 → 60 → 90 → → 450
↑

TOT operation

- When the continuous transmission time exceeds the set time, a warning tone will sound from 5 seconds before time is up and the transceiver will automatically switch to receive mode. At this time, further transmission cannot be performed unless the PTT key is set to off once.
(If the TOT penalty is set, transmission will not be possible even if the PTT is set to ON again from OFF within the set time.)

●8. TOT Penalty Time

This function prevents transmission by pressing the PTT key for the time set using the TOT Penalty Time function when a transmission has been halted by the TOT function.

1. TP-OFF is displayed on the LCD.
2. Rotate the dial to change the TOT Penalty Time setting.

●4. Tone Burst Frequency Setting

1. 1750 is displayed on the LCD.
2. Rotate the dial to change the tone burst frequency setting.

1750 → 2100 → 1000 → 1450
↑

●5. Clock Shift Setting

In the unlikely event that CPU clock noise is present on a particular operating frequency programmed into the radio, you can shift the CPU clock frequency to avoid the CPU clock noise, which normally is so weak that it is inaudible even if the radio is tuned exactly to its frequency.

1. SFT-OFF is displayed on the LCD.
2. Rotate the dial to toggle the clock shift setting on and off.

SFT-OFF → SFT-ON
↑

●6. Busy Channel Lockout Setting

This function restricts the transmission signal according to the receive state.

1. BCL-OFF is displayed on the LCD.
2. Rotate the dial to toggle the Busy Channel Lockout setting on and off.

BCL-OFF → BCL-ON
↑

- When Busy Channel Lockout is set to on, transmission is only possible in the following cases (and is not possible otherwise).

The alarm sounds if the PTT key is pressed when transmission is prohibited, and so no signal is output.

- ①When no signal is detected (BUSY is not displayed).
- ②When the tones match and the squelch is unmuted based on the tone squelch setting conditions.

TP-OFF → TP-1 → TP-4 → → TP-15
↑

Transmission is not possible until the penalty time elapses.

- An audible alarm is output if the PTT key is pressed during the penalty time.
- To suspend operation of the TOT Penalty Time function, after the TOT time elapses, press the PTT key continuously for a period that exceeds the penalty time setting.

●9. Theft Alarm Function

1. SCR-OFF is displayed on the LCD.
2. Rotate the dial to toggle the Theft Alarm on and off.

SCR-OFF → SCR-ON
↑

●10. External Terminal Control Output

1. EXP-OFF is displayed on the LCD.
2. Rotate the dial to toggle the External Terminal Control Output on and off.

EXP-OFF → EXP-ON
↑

●11. Mosquito Repel Function

1. MRS-OFF is displayed on the LCD.
2. Rotate the dial to toggle the Mosquito Repel function on and off.

MRS-OFF → MRS-ON
↑

● 12. Setting channel step

1. STP-5 is displayed on the LCD.
2. The channel step will change as shown below when the dial is turned.

← DOWN UP → (kHz)

STP-5 → STP-10 → STP-12.5 → STP-15 → STP-20 → STP-25 → STP-30

↑

- Channel step setting cannot be performed in memory mode.

Warning

- When the step value is changed between 5kHz, 10kHz, 15kHz, 20kHz, or 30kHz and either 12.5kHz or 25kHz, the frequency and shift width may be compensated when the change is completed.

● 13. Setting shift direction

1. SFD-OF is displayed on the LCD.
2. The shift direction will change as shown below when the dial is turned.

SFD-OF → SFD- - → SFD- +

↑

● 14. Setting shift frequency

Normally, the repeater is used in duplex mode. Specifically, the signal received on a certain frequency is retransmitted at a different frequency. The difference between these two frequencies is the shift frequency. The shift frequency can be set between 0 and 99.995MHz.

1. The shift frequency is displayed on the LCD.
2. Turn the dial to change the shift frequency by 1 channel step

intervals. To change the shift frequency in 1MHz intervals, hold the  key down while turning the dial.

● 15. Setting tone squelch

Refer to section 6.1: Tone squelch function. (page 21)

● 16. Setting tone frequency

Refer to section 6.1: Tone squelch function. (page 21)

● 17. Setting DCS

Refer to section 6.2: DCS function. (page 22)

● 18. Setting auto power off

This function prevents the batteries from being exhausted when you forget to switch off the power.

1. APO-OF is displayed on the LCD.
2. The auto power off setting will change between ON and OFF when the dial is turned.

APO-OF → APO-ON

↑

3. The auto power off setting will change between ON and OFF when the dial is turned.

APO operation

- When APO is displayed on the LCD, if no operation is performed for approximately 30 minutes, a beep will sound and the power of the transceiver will automatically be switched off. To switch the transceiver back on, set the

8

28

power switch to ON again.

- The APO time is not extended when a signal is received. Only key operations will extend the APO time.

● 19. Setting skip channel

1. SKP-OF is displayed on the LCD.
2. The skip channel setting will change between ON and OFF when the dial is turned.

SKP-OF → SKP-ON

↑

3. When the setting is set to ON, the 10MHz decimal point for the set memory channel is displayed. This setting is shown only in memory mode.

8

29

9 CLONING AND PACKET OPERATION

9.1 CLONING

With the Cloning function, it is possible to connect two transceivers by a cable, and copy all settings from one unit to the other (including memory data).

● Connection Method

- Connect the speaker jacks of the sending transceiver and the receiving transceiver using a ϕ 3.5 stereo mini-plug cord as shown in the diagram.
- Be certain that both units are switched off before connecting them.

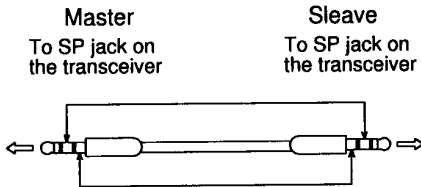

- After connecting the units, switch them both on.

● Master Transceiver Operation

1. Press the PTT key three times while holding down the MONI key.

“CLONE” is displayed on the LCD, and the transceiver enters Clone mode.



2. In this state, press the PTT key. SD*** is displayed on the LCD, and the internal settings of the transceiver are transferred to the second unit.

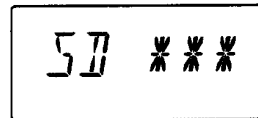

3. After the transfer is completed, “PASS” is displayed.

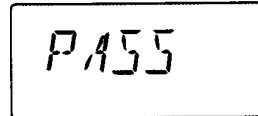

4. Switch to power off to cancel Clone mode. If the data was not transferred successfully, “PASS” is not displayed. Repeat the procedure in this case.

9

30

● Slave Transceiver Operation

1. When the data is sent from the transmission unit, LD*** is displayed on the receiving unit, and the data is transferred.

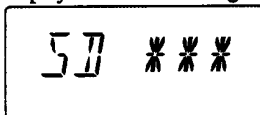

2. After the transfer is completed, “PASS” is displayed.

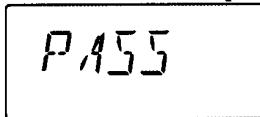

3. After the cloning done, to turn the radio OFF by pressing the  key.

If the data was not transferred successfully, “PASS” is not displayed. In this case, repeat the procedure from the transmission unit side or reset the receiving unit setting (10.2 Resetting (page 33)). Using the slave transceiver as is after an unsuccessful data transfer can result in erroneous operation.

⚠ CAUTION

- Do not disconnect the cable during data transmission. If you disconnect the cable at this time, “COMERR” is displayed on the LCD of the master unit, and transmission is aborted.
- When data transfer is performed using the Clone function, all settings in the slave unit are overwritten by the master unit settings. Take due care.

9.2 Packet Operation

Packet operation is used for data communication (from a computer, etc.).

● Packet Operation Connections

Connect the packet communication TNC (Terminal Node Controller) terminals to the SP (ϕ 3.5 mm plug) and MIC (ϕ 2.5 mm plug) connectors on the top of the transceiver.

- Input level adjustment : The transceiver has no MIC level adjustment circuit. Adjust the level on the TNC side.
- Output level adjustment : Use the volume dial on the top of the transceiver.

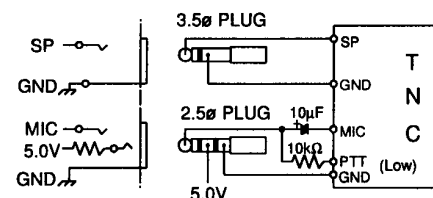

*Power is supplied from internal 5V line through 100 Ω resistor.

⚠ CAUTION

- Refer to the TNC's instruction manual when connecting the TNC unit to other devices (personal computer etc.). If the transceiver, TNC unit and connected personal computer are too close together, noise between them may cause interference.
- Turn the battery save function off during packet operation.
- Operate up to 1200bps.

9

31

10 MAINTENANCE AND REFERENCE

10.1 Troubleshooting





Please check the list below before concluding that the transceiver is faulty. If a problem persists, reset the transceiver. This can sometimes correct erroneous operation.

Symptom	Possible Cause	Action
Nothing appears on the display when you turn the power on.	Poor Ni-Cd battery pack connection.	Check that the battery pack terminals are clean.
	Battery is run down.	Recharge battery.
	You are releasing the key too quickly.	Hold the POWER key down longer.
No speaker audio. No reception.	Volume too low.	Adjust the volume.
	Squelch level too high.	Adjust the squelch.
	Tone squelch is on.	Turn off tone squelch.
	DCS is on.	Turn off DCS.
	You are pressing the PTT key and transmitting.	Release PTT key.
Frequency display is incorrect.	CPU error.	Reset.
	A channel name is set.	See Naming Memory Channels function.
Won't scan.	Squelch is unmuted.	Set squelch so that noise is just muted.
Frequency and memory number do not change.	Keylock is on.	Turn off keylock.
	Transceiver is in the call mode.	Go to VFO mode or memory mode.
Key entry not possible.	Keylock is on.	Turn off keylock.
Cannot transmit. Display flashes or goes out when you transmit.	Battery is run down.	Recharge battery.
Cannot transmit. Not replay when you transmit.	Not pressing PTT key firmly enough.	Press the PTT key and confirm that TX/RX lamp lights red.
	You are off band. (when shift is set.)	Transmit within transmission frequency range.
	Incorrect frequency.	Match your frequency to receiving station frequency.
The display flashes or disappears during reception.	Battery is run down.	Recharge battery.

32

10.2 Resetting

When you reset the transceiver, all settings are returned to the initial factory settings. Existing memory channel settings will be lost.

- Switch on the power by pressing the  key while holding down the  key.
- All of the LCD segments are displayed. Release the  and  keys. The initial mode for the transceiver is VFO mode.

Factory setting

	DJ-193T	DJ-193E	DJ-493T	DJ-493E
VFO Frequency	145.000MHz	145.000MHz	445.000MHz	433.000MHz
CALL Frequency	145.000MHz	145.000MHz	445.000MHz	433.000MHz
Memory Channel	0-39ch Blank	0-39ch Blank	0-39ch Blank	0-39ch Blank
Channel Step	5kHz	12.5kHz	5kHz	12.5kHz
Shift	None	None	None	None
Offset Frequency	0.6kHz	0.6kHz	5MHz	7.6MHz
Tone Setting	None	None	None	None
Tone Frequency	88.5Hz	88.5Hz	88.5Hz	88.5Hz
DCS Setting	None	None	None	None
DCS Code	023	023	023	023
Transmitter Output	Low	Low	Low	Low
Key Lock	Off	Off	Off	Off
Time Out Timer	Off	Off	Off	Off
Auto Power Off	Off	Off	Off	Off
Volume Level	0	0	0	0
Squelch Level	0	0	0	0

10.3 Options

- EBP-48N Ni-Cd battery (9.6V DC 700mAh)
- EDC-36 Mobile Cigarette lighter adapter with active noise filter
- EDC-37 External DC supply cable
- EDC-88 Quick charger (120/230V)
- EDC-93 Wall charger (120V)
- EDC-94 Wall charger (230V)
- EMS-9 Speaker microphone
- EMS-51 Speaker microphone
- EME-6 Earphone
- EME-12 Headset with VOX
- EME-13 Earphone and mic with VOX
- EME-15 Tie-pin mic with VOX
- EBC-6 Mobile bracket
- ESC-36 Softcase (for use with EBP-48N)

10

11 SPECIFICATIONS

11.1-1 General <DJ-193>

Frequency range
T: TX144~147.995MHz
RX135~173.995MHz
E: TX144~145.995MHz
RX144~145.995MHz
TFH: TX150~173.995MHz
RX135~173.995MHz

Modulation: F3E(FM)
Frequency step: 5, 10, 12.5, 15, 20, 25, 30kHz step
Memory channel: 40 channels + 1call channel
Ant. impedance: 50 Ω unbalanced
Frequency stability: ± 5 ppm
Mic. impedance: 2k Ω
Supply voltage: 6.0~16.0VDC
Current consumption: 5W output: approx. 1.2A
280mW rating output: approx. 200mA
Squelch reception: approx. 50mA
Battery save on: approx. 20mA

Temperature range: $-10^{\circ}\text{C} \sim +60^{\circ}\text{C}$ ($+14^{\circ}\text{F} \sim +140^{\circ}\text{F}$)
Ground: Negative ground
Dimension: 56(W) \times 124(H) \times 40(D)mm
(2.20"(W) \times 4.88"(H) \times 1.57"(D))
(with EBP-48N)
Weight: Approx. 375g (13.2oz)
(with EBP-48N)

Subaudible Tone (CTCSS): encoder/decoder installed(39 tones)
Subaudible Tone (DCS): encoder/decoder installed(104 codes)

11.1-2 Transmitter

Power output: Approx. 5W (with EBP-48N)
Approx. 5W (13.8VDC)
Approx. 0.8W (LOW output)

Modulation: Variable reactance
Spurious emission: -60 dB or less
Max. deviation: ± 5 kHz
Mic. impedance: 2k Ω

11.1-3 Receiver

System: Double-conversion superheterodyne
Sensitivity: -14.0 dB μ (0.2 μ V) or less
(144~147.995MHz)
 -12.0 dB μ (0.25 μ V) or less
(135~173.995MHz)

Intermediate frequency: 1st IF 21.7MHz 2nd IF 450kHz
Sensitivity: -6 dB: 12kHz or more
 -60 dB: 26kHz or less

AF output: 280mW (MAX)
200mW (8 Ω , 10% distortion)

11

34

11.2-1 General <DJ-493>

Frequency range
T: TX430~449.995MHz
RX430~449.995MHz
E: TX430~439.995MHz
RX430~439.995MHz

Modulation: F3E(FM)
Frequency step: 5, 10, 12.5, 15, 20, 25, 30kHz step
Memory channel: 40 channels + 1call channel
Ant. impedance: 50 Ω unbalanced
Frequency stability: ± 5 ppm
Mic. impedance: 2k Ω
Supply voltage: 7.0~16.0VDC
Current consumption: 5W output: approx. 1.4A(13.8VDC)
280mW rating output: approx. 200mA
Squelch reception: approx. 50mA
Battery save on: approx. 20mA

Temperature range: $-10^{\circ}\text{C} \sim +60^{\circ}\text{C}$ ($+14^{\circ}\text{F} \sim +140^{\circ}\text{F}$)
Ground: Negative ground
Dimension: 56(W) \times 124(H) \times 40(D)mm
(2.20"(W) \times 4.88"(H) \times 1.57"(D))
(with EBP-48N)
Weight: Approx. 375g (13.2oz)
(with EBP-48N)

Subaudible Tone (CTCSS): encoder/decoder installed(39 tones)
Subaudible Tone (DCS): encoder/decoder installed(104 codes)

11.2-2 Transmitter

Power output: Approx. 4W (with EBP-48N)
Approx. 5W (13.8VDC)
Approx. 0.8W (LOW output)

Modulation: Variable reactance
Spurious emission: -60 dB or less
Max. deviation: ± 5 kHz
Mic. impedance: 2k Ω

11.2-3 Receiver

System: Double-conversion superheterodyne
Sensitivity: -12.0 dB μ (0.25 μ V) or less
(430~449.995MHz)

Intermediate frequency: 1st IF 45.1MHz 2nd IF 455kHz
Sensitivity: -6 dB: 12kHz or more
 -60 dB: 26kHz or less

AF output: 280mW (MAX)
200mW (8 Ω , 10% distortion)

11

35